



SAN MATEO COUNTY • CALIFORNIA
COMMUNITY DESIGN MANUAL

SAN MATEO COUNTY ▪ CALIFORNIA
COMMUNITY DESIGN MANUAL

ADOPTED BY THE PLANNING COMMISSION ▪ FEBRUARY 25, 1976
ADOPTED BY THE BOARD OF SUPERVISORS ▪ JULY 20, 1976

CONTENTS

- INTRODUCTION 3
- SITE DESIGN 5
 - SITING 6
 - GRADING 7
 - VEGETATIVE PRESERVATION 8
 - LANDSCAPING 10
 - WATER 11
 - VIEW PRESERVATION 12
 - OPEN SPACE PRESERVATION 14
 - RIDGELINES 15
 - CLIFFS & BLUFFS 16
 - ACCESSORY STRUCTURES 17
 - PAVED AREAS 18
 - UTILITIES 20
 - SIGNS 21

- EXTERIOR APPEARANCE 23
 - COLORS & MATERIALS 24
 - STRUCTURAL SHAPES 25
 - SCALE 26

- NON-RESIDENTIAL DEVELOPMENT 27
 - COMMERCIAL 28
 - INDUSTRIAL 29

- APPENDIX 31
 - DESIGN REVIEW CHECKLIST 33
 - DESIGN REVIEW (DR) ZONING ORDINANCE . . . 34

INTRODUCTION

This Community Design Manual was created to provide guidelines by which the County Design Review Administrator may evaluate individual building permits where the Design Review Zoning District is combined with existing zoning districts. The Manual is designed to be flexible in structure and organization so that additional guidelines and criteria may be added in the future.

Good design can create a Community which is clearly definable, pleasant to live in, and economically viable.

The appearance of spaces, buildings, and structures has a material and substantial relationship to property values. In the past, many communities and neighborhoods have deteriorated through poor planning, neglect of proper design standards, and the erection of buildings and structures unrelated to the sites and incompatible with the character of the neighborhood. This has resulted in the destruction of desirable natural land and vegetative forms, the creation of drainage and erosion problems on adjacent property, and the construction of structures out of scale and harmony with their neighborhoods.

It is the policy of San Mateo County to avoid and prevent possible Community deterioration, through the implementation of the design criteria set forth in this Manual. These criteria will help to preserve and enhance property values, the visual character of communities, natural resources, and the public health, safety, and welfare of the citizens of San Mateo County.

It is the intent of the County, through the implementation of this Design Manual, to accomplish the following:

1. To improve the general standards of orderly development of the County through design review of individual buildings, structures, and their environs.
2. To improve and augment the controls now included in ordinances related to planning and building in order to promote development which is in the best interest to the public health, safety, and welfare of the County.
3. To establish standards and policies that will promote and enhance good design, site relationships, and other aesthetic considerations in the County.

In order to accomplish these goals, the Community Design Manual does not set forth rigid rules for designing structures but rather establishes general guidelines in which considerable latitude remains, so as to not stifle individual initiative.

SITE DESIGN

SITING

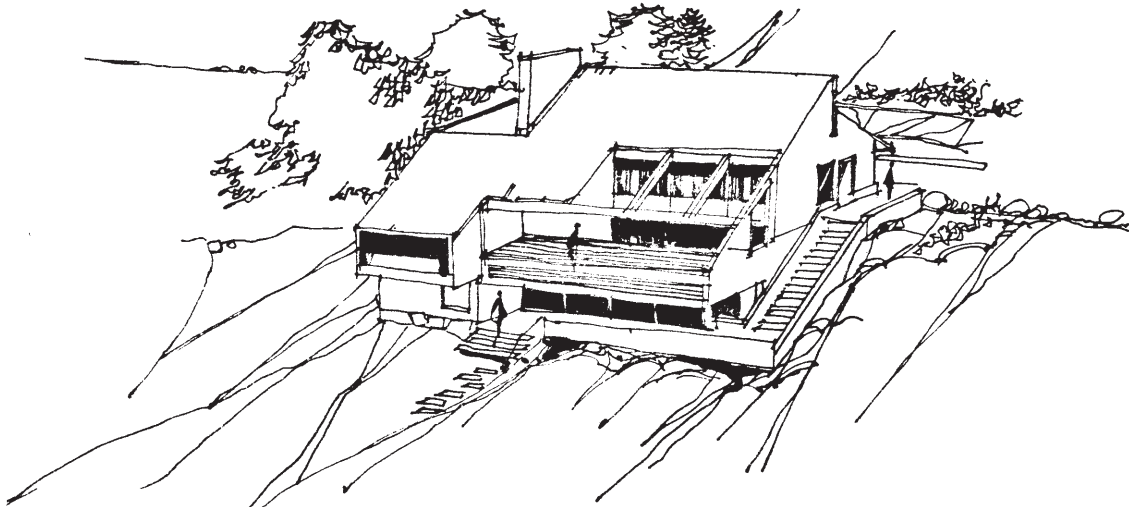

THIS

Structure is designed to blend with the natural contours and features of the site. Only grading necessary for construction was used.

- Structures and accessory structures should be located, designed, and constructed to retain and blend with the natural vegetation and natural land forms of the site (i.e., topography, rock out-croppings, ridgelines, tree masses, etc.), and should be complementary to adjacent neighborhood structures.

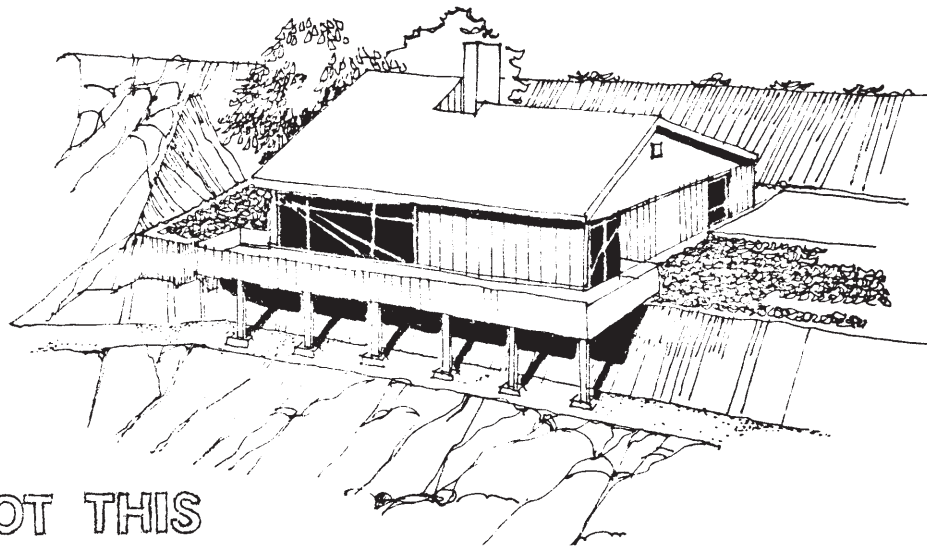

NOT THIS

Structure is not suited to the terrain. Extensive grading was required to create building pad.

GRADING

- Grading and vegetation removal should be minimized and allow for only the construction of the structure and paved areas such as driveways and paths. Should grading be required, such work should blend into adjacent land forms through the utilization of contour grading rather than cutting, filling, padding or terracing the site.
- To ensure minimal impact on the physical setting of the site and adjacent properties, site preparation, grading and structure location should be carefully controlled to reduce erosion, soil exposure, impacts on natural drainage systems, and to maintain surface runoff at or near existing levels. Grading or removal of vegetation which could contribute to the instability of the site or adjacent property should not be permitted.

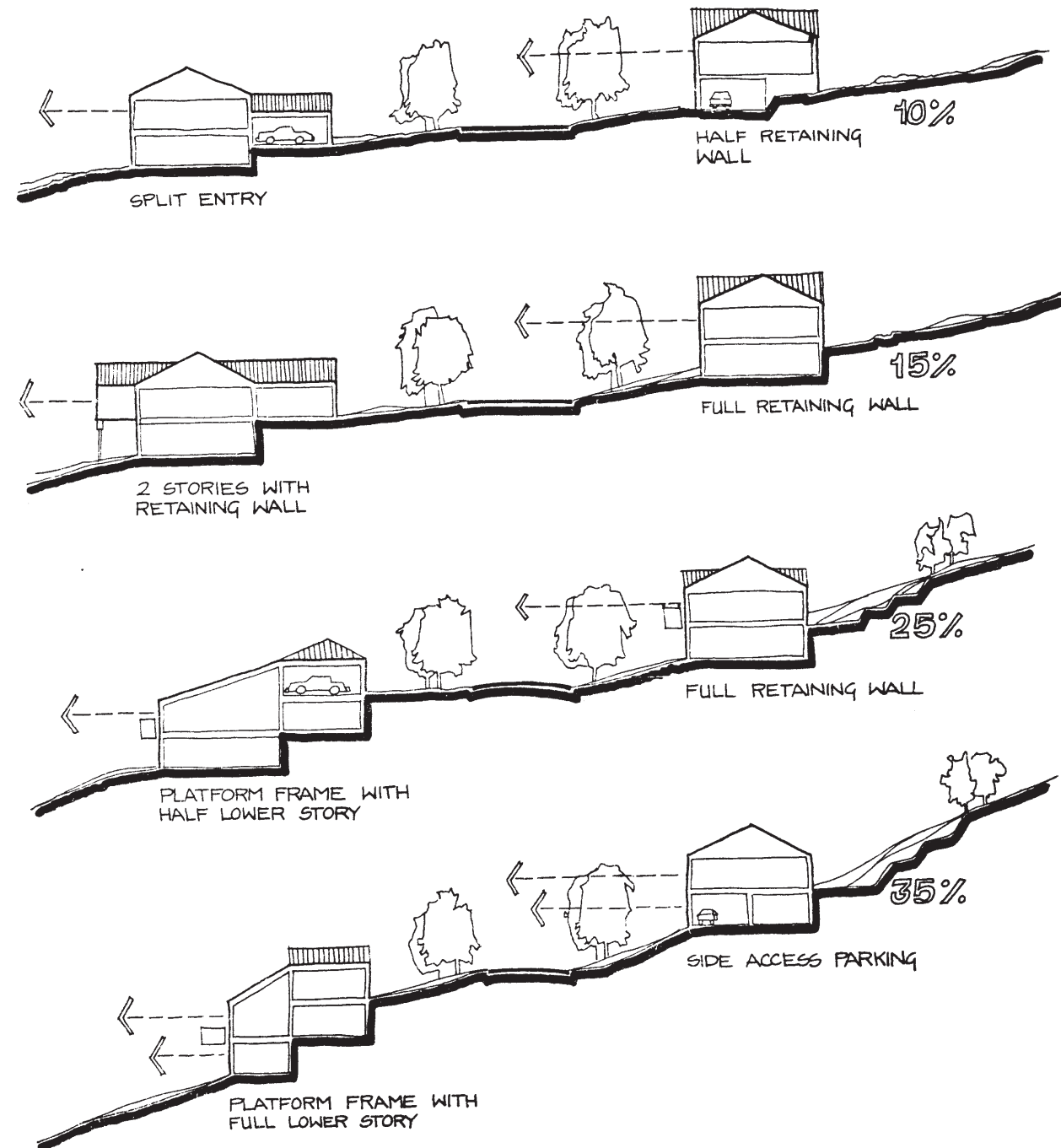

VEGETATIVE PRESERVATION

EXISTING SITE

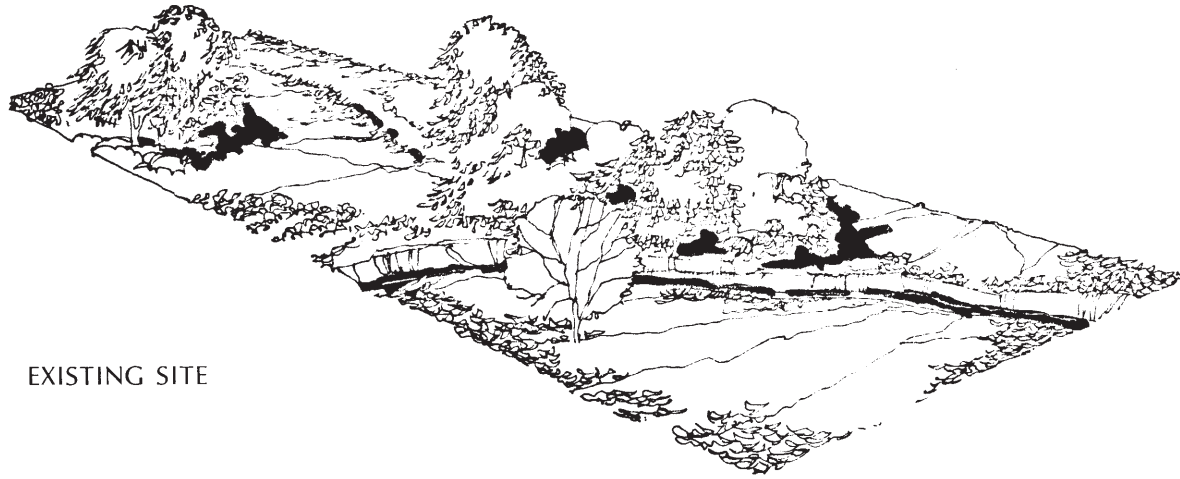

THIS
SENSITIVE SITE DEVELOPMENT

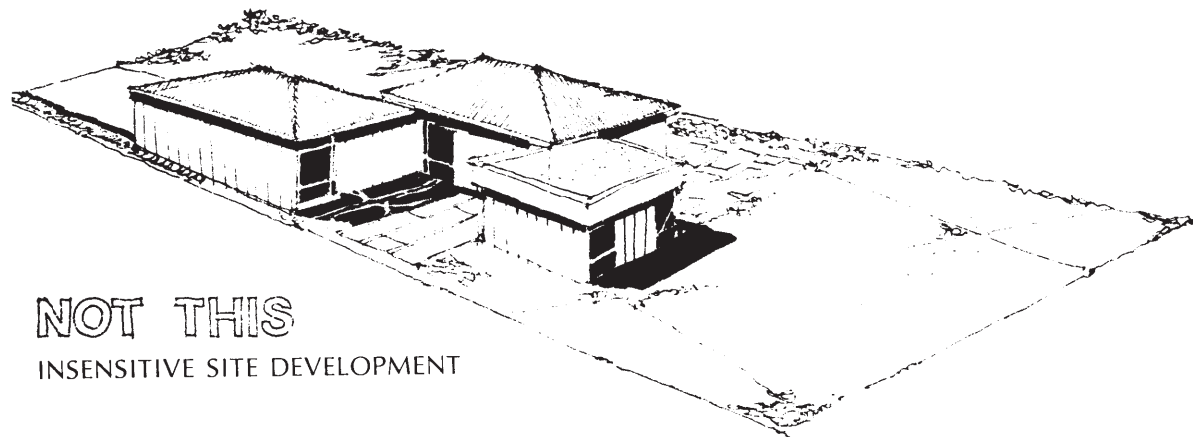

NOT THIS
INSENSITIVE SITE DEVELOPMENT

- Structures should blend with the natural vegetative cover of the site and only that vegetation should be removed which is necessary for the construction of the structure.
- Structures should be designed around major trees or tree stands.

EXISTING SITE

Physical conditions prior to development. Note the stream channel and the wide variety of vegetation.

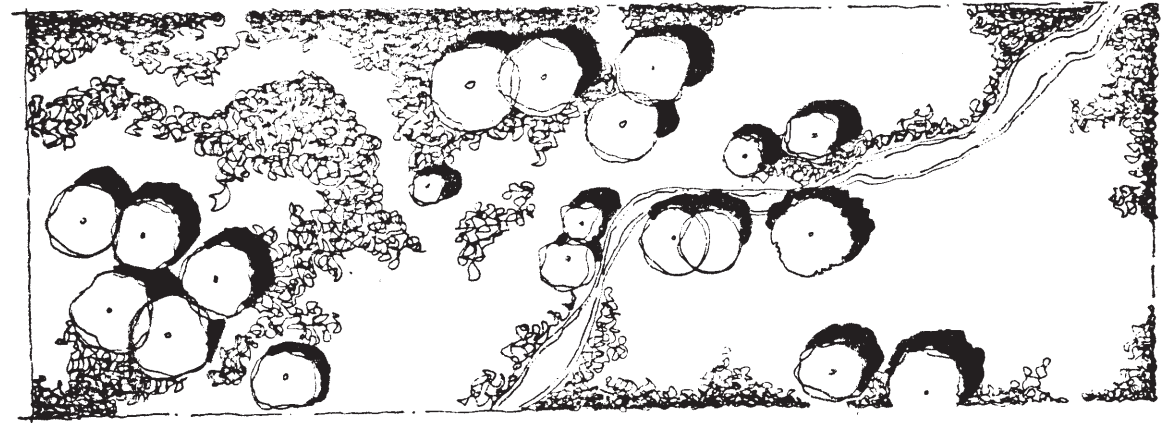

SENSITIVE SITE DEVELOPMENT

Structure has been designed to integrate with site conditions. Note that the major vegetative and tree masses and the stream channel have been retained in their natural state, reducing the physical and visual impact of the structure on the site.

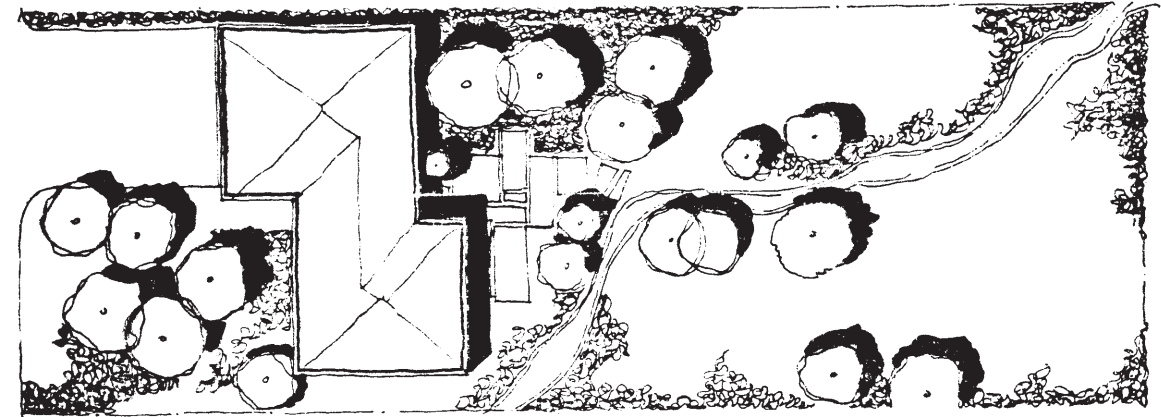

INSENSITIVE SITE DEVELOPMENT

Structure design and location did not consider the natural features of the site. Major vegetative and tree masses were removed and the stream channel obliterated creating potential erosion and flood problems on the site and adjacent property.

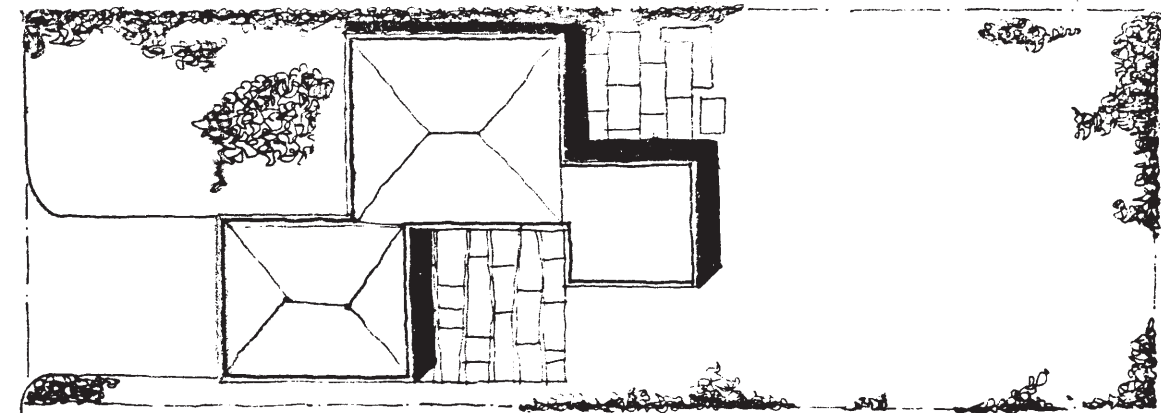

LANDSCAPING

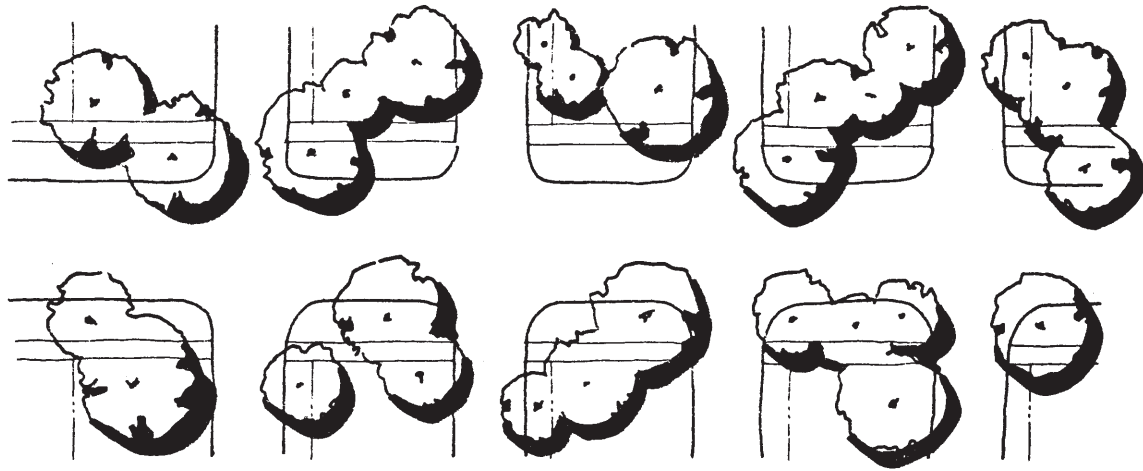

THIS

Introduced vegetation is planted in an irregular fashion to give an informal character.

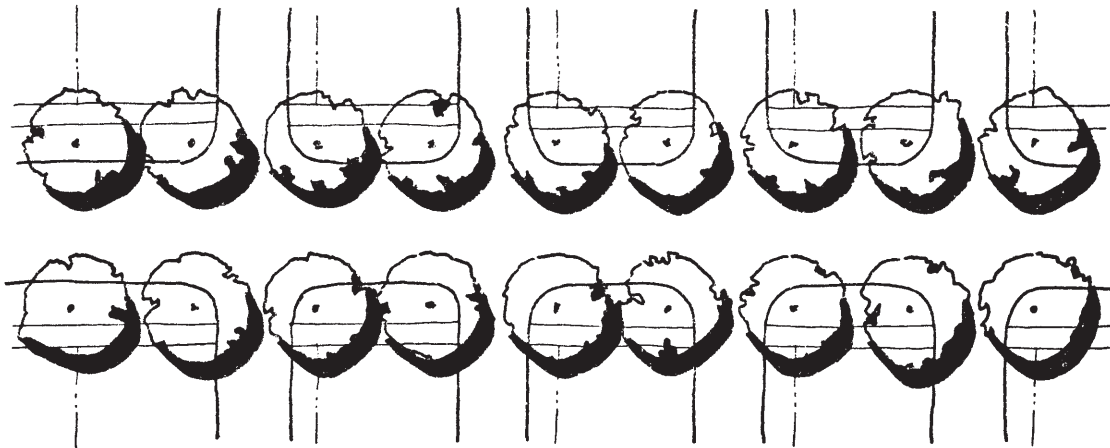

NOT THIS

Introduced vegetation is planted in a linear pattern which produces a rigid appearance.

- Landscaping material should have an informal character and should provide a smooth transition between the development and adjacent open space areas.
- Only tree and plant materials native to the area should be used to assure against non-native plant intrusion to reduce irrigation and maintenance requirements, and to minimize visual impact.
- Additional planting may be required where existing or proposed plant material is considered insufficient. Planting should be placed so that it does not constitute a safety hazard.
- On coastal terrace and open foothill lots, landscaping should be placed only around structures.

WATER

- With the exception of trails and paths, and related appurtenances, structural development should be set back from and not permitted to be constructed where such development will adversely affect a stream, drainage area, or body of water.

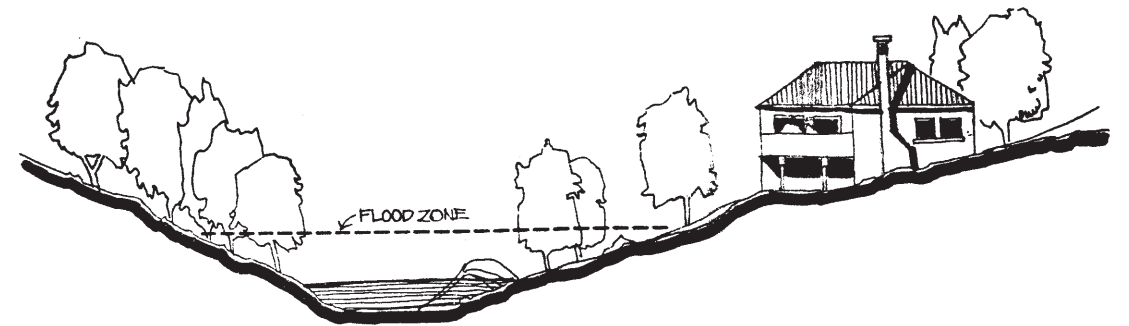

THIS

Structure is located outside dangerous flood zone or drainage channel, and does not affect the character of the stream or water habitat.

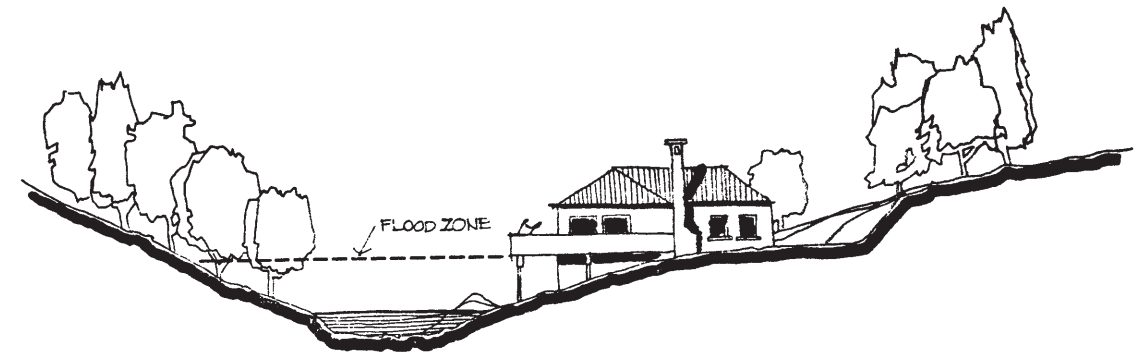

NOT THIS

Structure is located within dangerous flood zone, impairing drainage, changing stream character, and impacting water habitat.

VIEW PRESERVATION

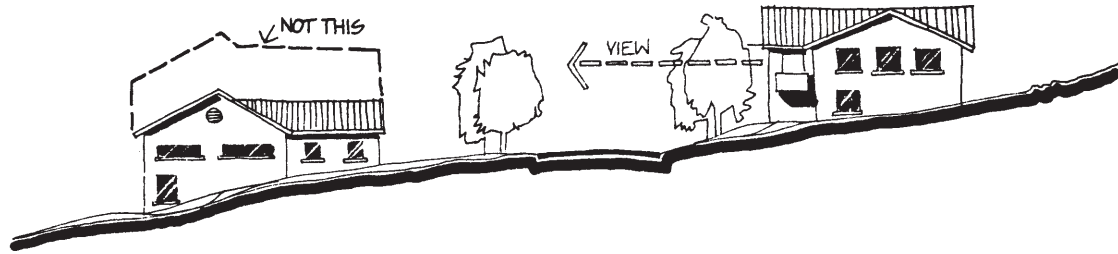

Height of structure is designed to protect views from uphill structures.

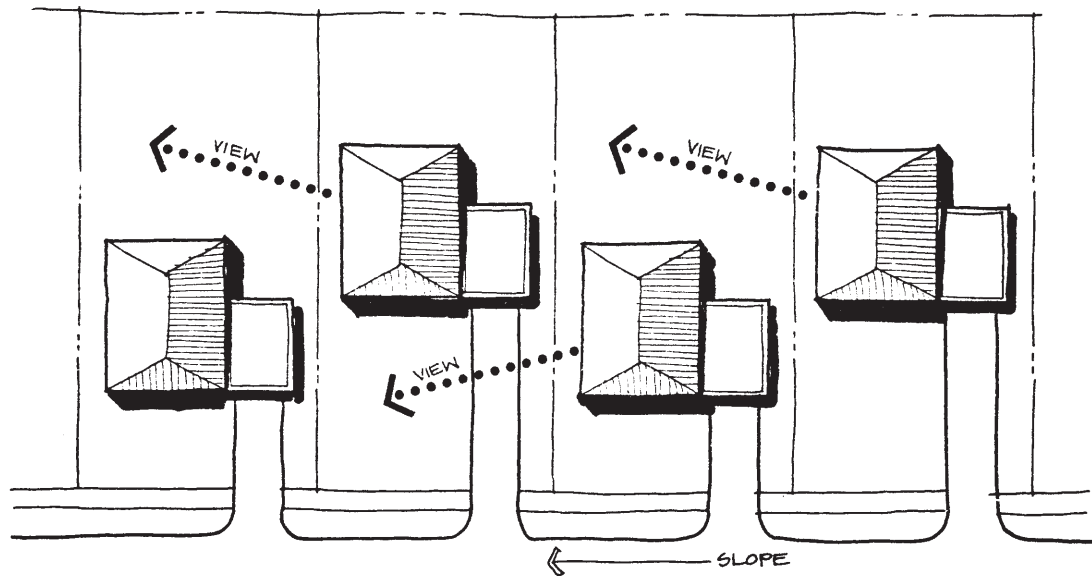

Structures are located to maximize views on sloping lots.

- Views should be preserved by limiting structure height. Introduced vegetation should be located so as to not block views from uphill structures or views from scenic corridors and vista points.
- Public views within and from scenic corridors should be protected and enhanced, and development should not be allowed to significantly obscure, detract from, or negatively affect the quality of these views. Visual screening or increased setbacks may be used to mitigate such impacts.
- Structures should be located to retain views of prominent scenic features, i.e., bodies of water, mountains, valleys, etc.
- Trees and vegetation may be selectively pruned or removed at the end of view corridors to enhance scenic vistas.

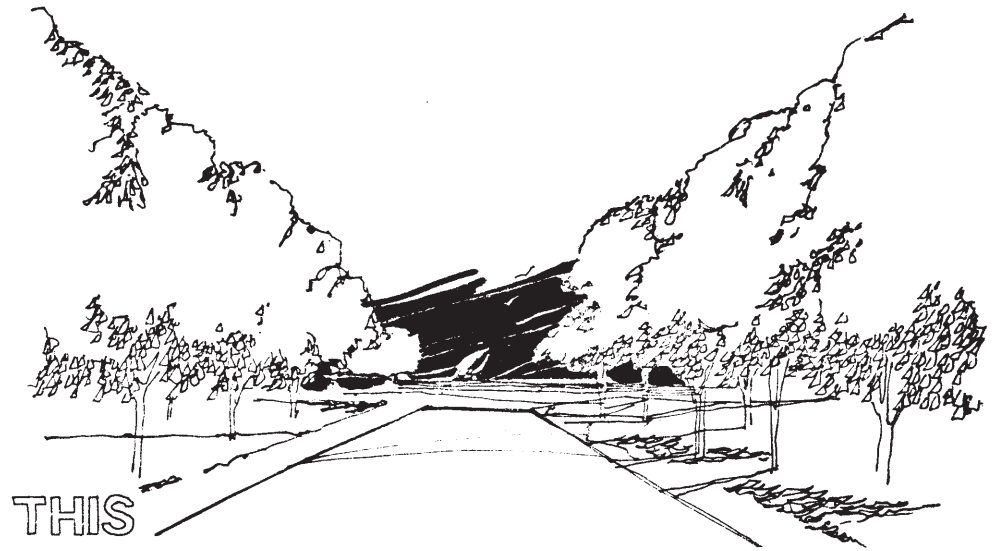
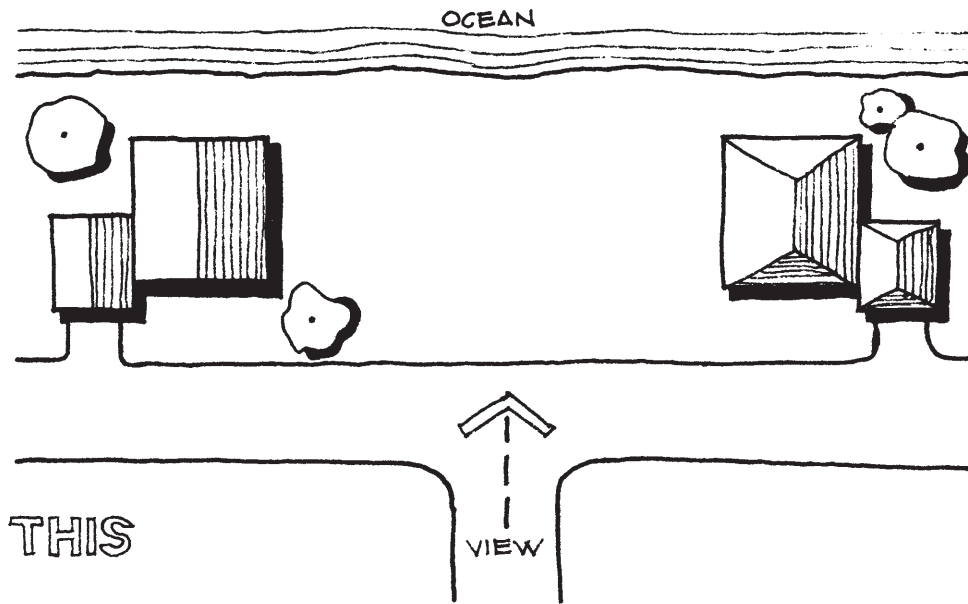

Views are maintained by the preservation of open space at the end of view corridor.

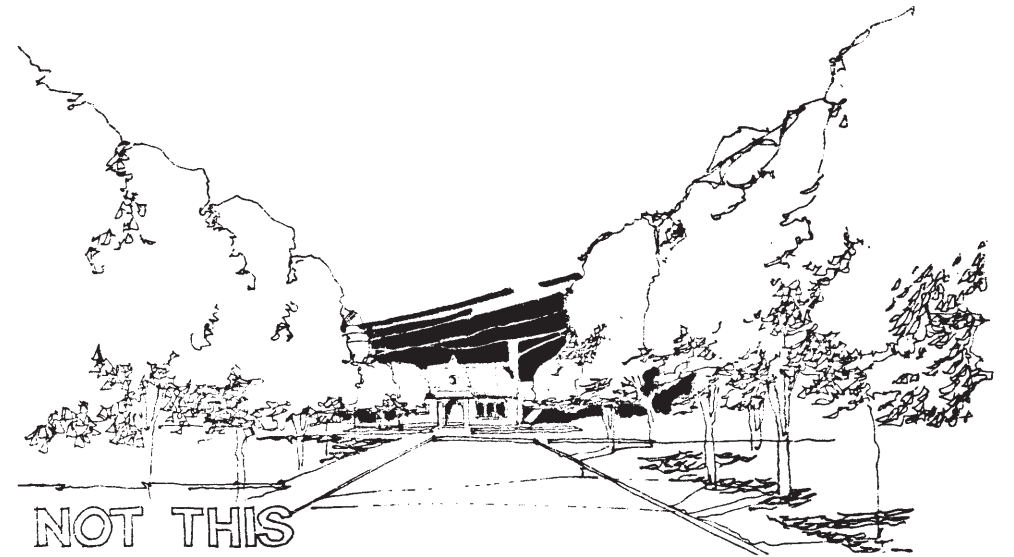
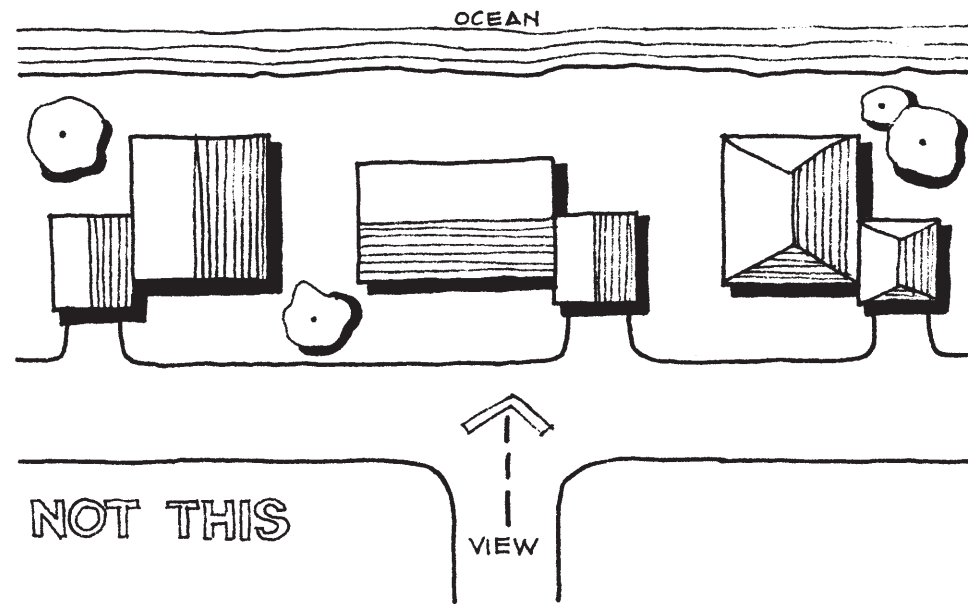

Views are blocked by the construction of structure at the end of view corridor.

OPEN SPACE PRESERVATION

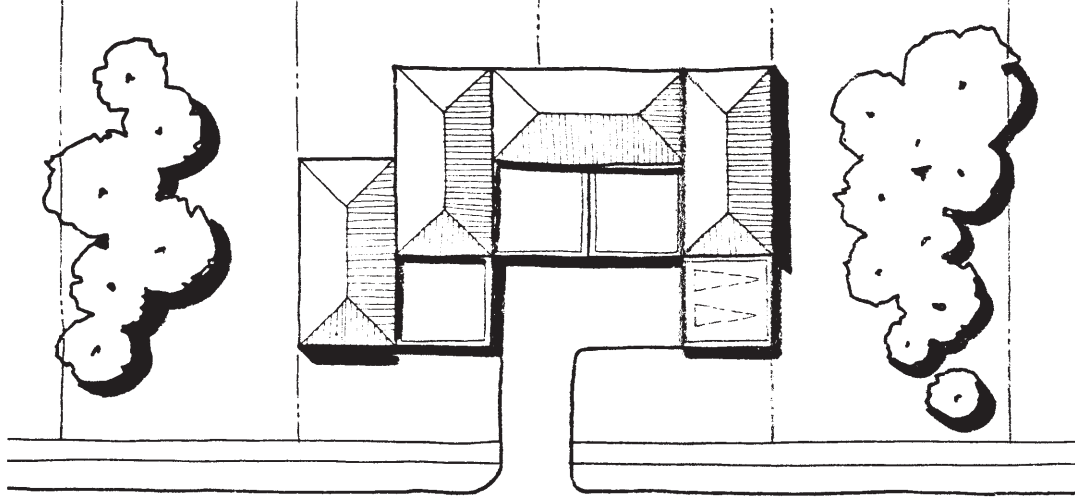

THIS Structures are clustered to create a greater amount of usable open space.

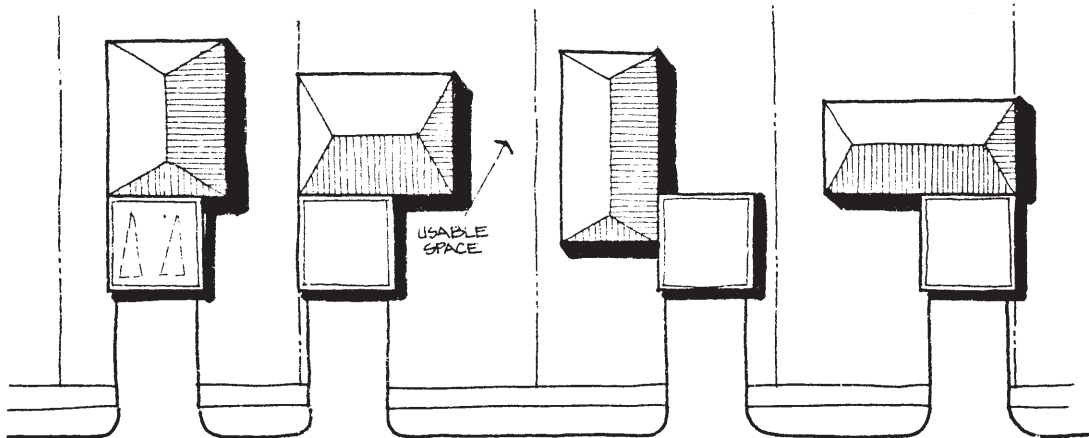

THIS Sideyard setbacks have been varied to create more usable open space between structures.

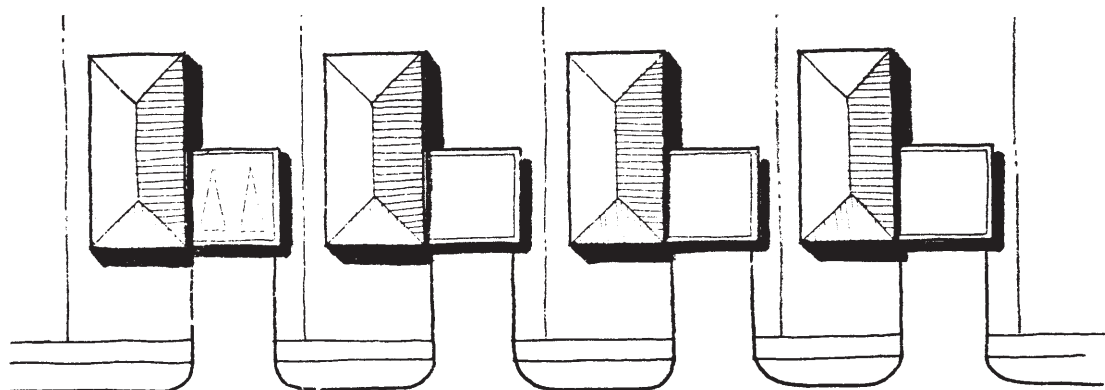

NOT THIS Rigid sideyard setbacks break open space into small unusable sections.

- Structures should be sited to retain maximum open space and to reduce the visual impact in scenic open space areas.
- Where possible, structures should be clustered near existing natural and man-made vertical features such as tree masses, hills, and existing structures.
- Contiguous undeveloped lots, especially those under the same ownership, should be consolidated to create large building sites and encourage clustering, thereby retaining a greater area in open space.
- Where conditions permit, minimum sideyard requirements may be reduced or increased as long as the total required setback is maintained.

RIDGELINES

- Any construction on ridgelines should blend with the existing silhouette and not break or cause gaps within ridgeline silhouettes, such as the removal of tree masses or the construction of structures which do not relate to the ridgeline form.
- In forested or wooded areas, no structures or appurtenance should extend above the height of the forest or tree canopy or break the continuity of the existing canopy.



Existing conditions.



THIS

Structures blend with existing land forms and vegetation.

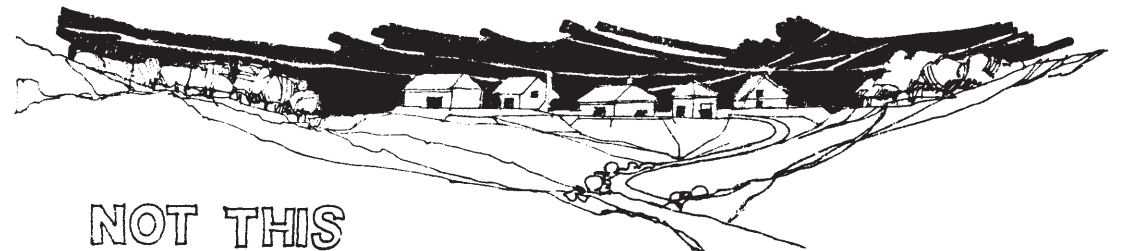

NOT THIS

Ridgeline silhouette has been destroyed through the removal of vegetative masses and natural land forms.

CLIFFS AND BLUFFS

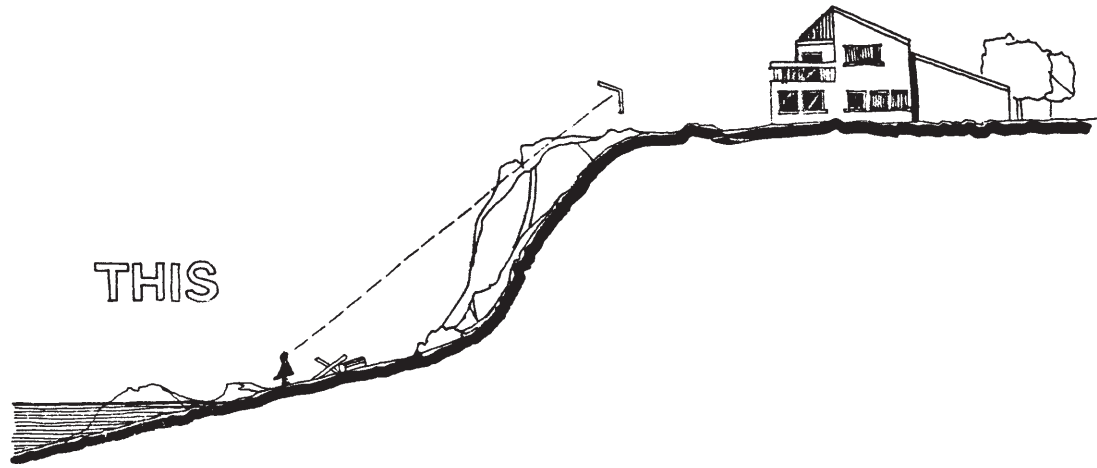

Structure is set back to protect cliff and view from scenic area.

- Structures should be set back from bluffs and cliffs so as to not destroy natural land forms.
- Intrusion of structures into views from scenic areas should be minimized.

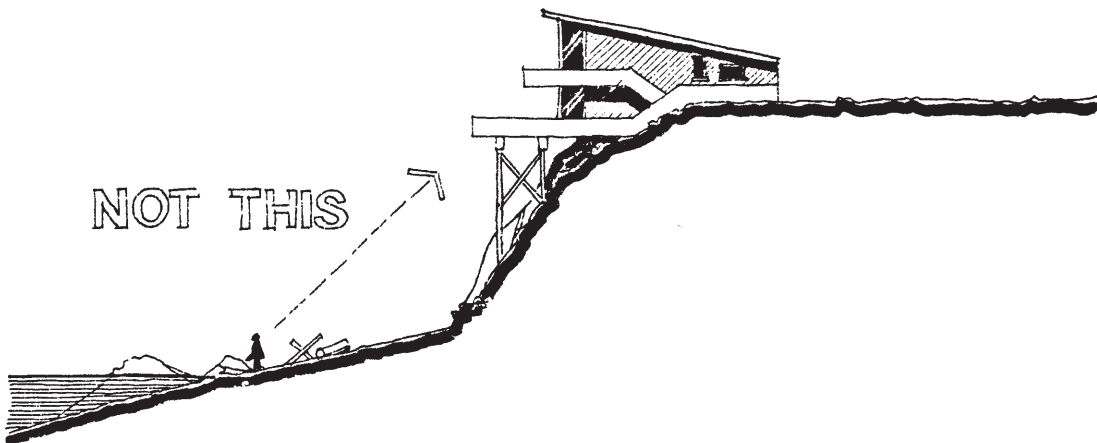

Structure erected on cliff destroys natural features and view from scenic area.

ACCESSORY STRUCTURES

- Accessory structures should be located in the immediate vicinity of the main structure(s), should be visually integrated with the main structure(s), and blend in with the natural terrain and vegetation of the site.
- Fences should be built to fit the natural contours of the land. Use of living (vegetative) fences in conjunction with earth berms, and fences made of natural materials are encouraged.

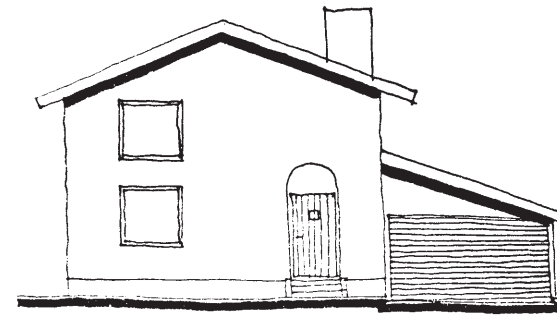

THIS

Accessory structure is visually integrated with the main building.

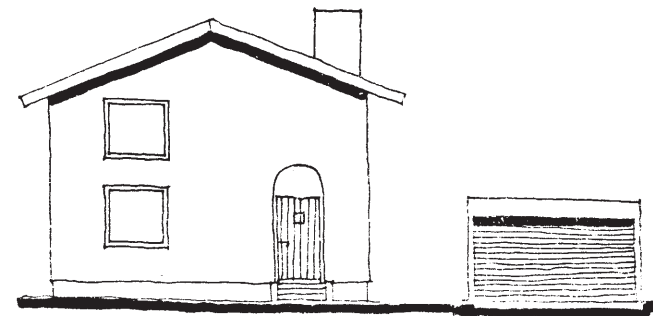

NOT THIS

Accessory structure does not relate in form or appearance to the main building.

PAVED AREAS

- Paved areas such as parking lots, driveways, sidewalks, etc., should be well integrated into the site, relate to existing and proposed structures and landscaped to reduce visual impact.
- Small separate paved parking lots are preferred to large single paved lots.
- Parking areas should be screened from residential areas and from scenic roadways.
- Driveways should be shared when feasible to reduce curb cuts, especially along major arterials and scenic roads.
- Paving materials used for pathways, sidewalks, driveways, and parking areas should be varied, textured, colored or patterned to add visual interest, especially where visible from above.

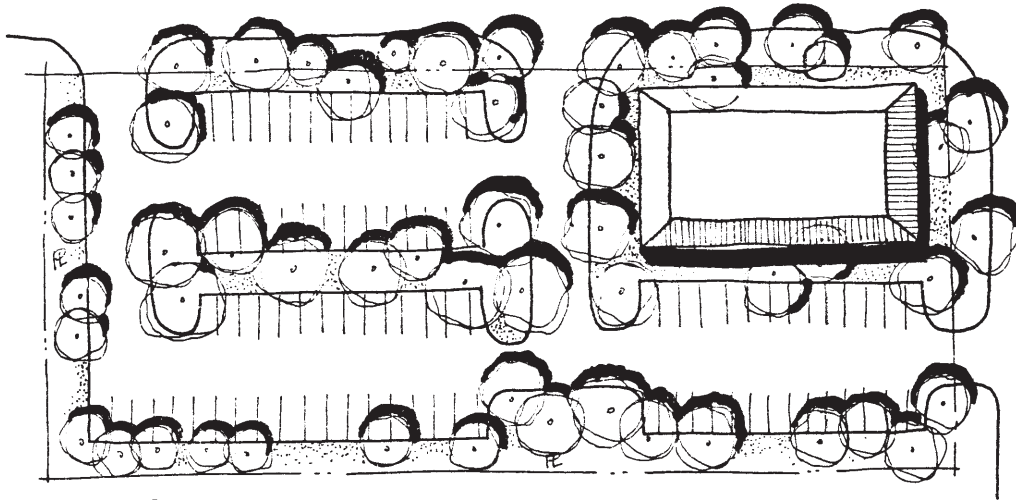

THIS

Visual interest is added to the parking lot through the extensive use of landscaping.

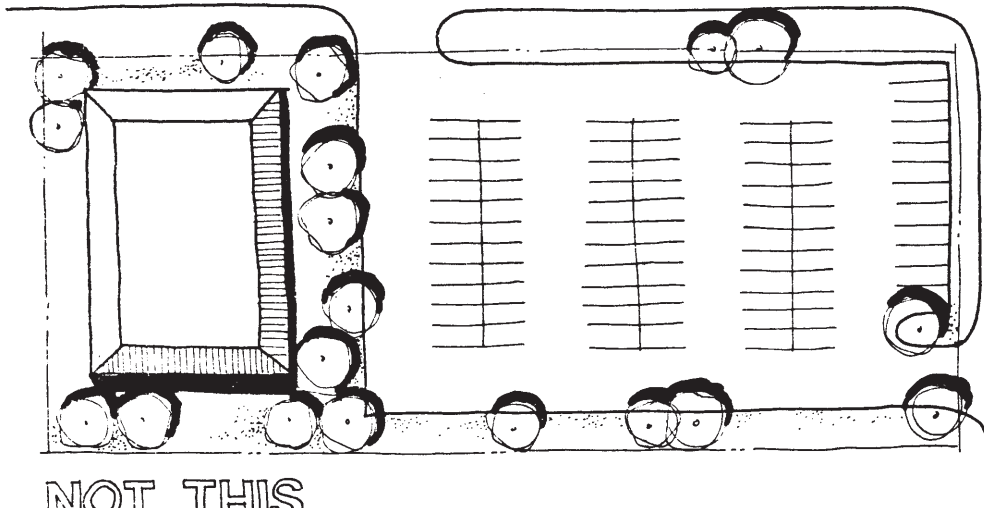

NOT THIS

Large unbroken expanses of parking area with little landscaping lack visual interest.

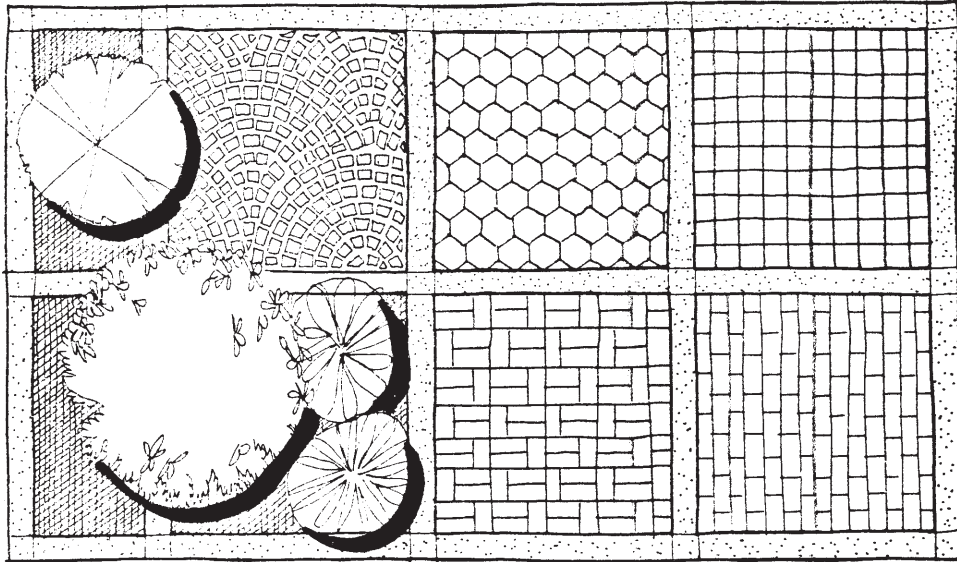

- This illustrates various material patterns and textures which can be used for paved areas to create visual interest.

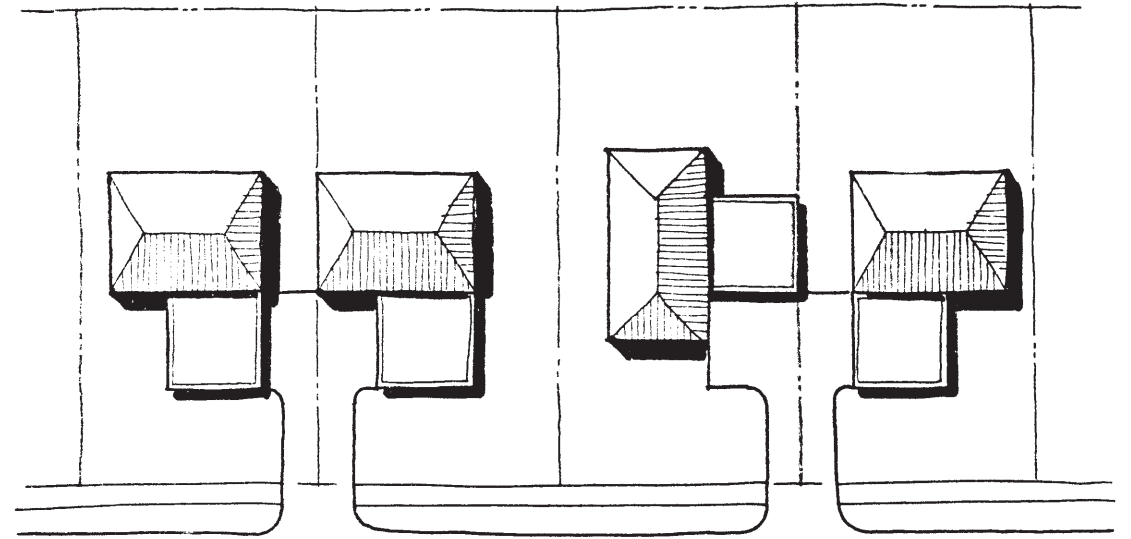

THIS

Common driveways are used to reduce curb cuts and to increase the amount of usable open space.

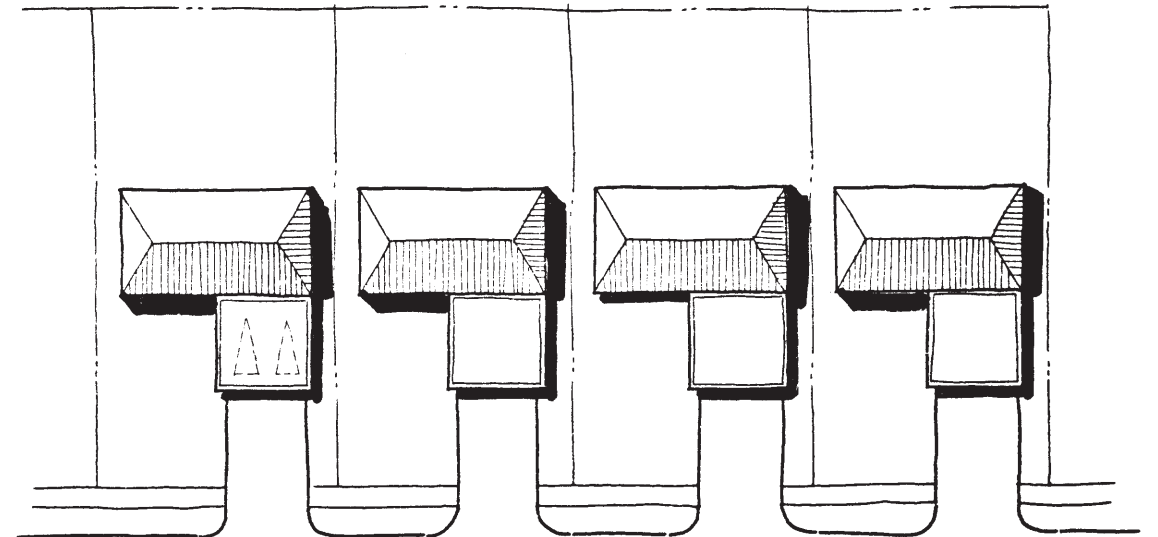

NOT THIS

Individual driveways increase the number of hazardous curb cuts and create smaller, less usable open space areas.

UTILITIES

- Public utility structures, including luminaries, overhead wires and utility poles should be of minimum bulk and height, should be designed to have an uncluttered appearance, and should be subordinate to or blend with the natural setting and community.
- Underground utility lines should be required except where such undergrounding would result in significant adverse environmental impacts. Utility structures should not be visible above ridgelines.

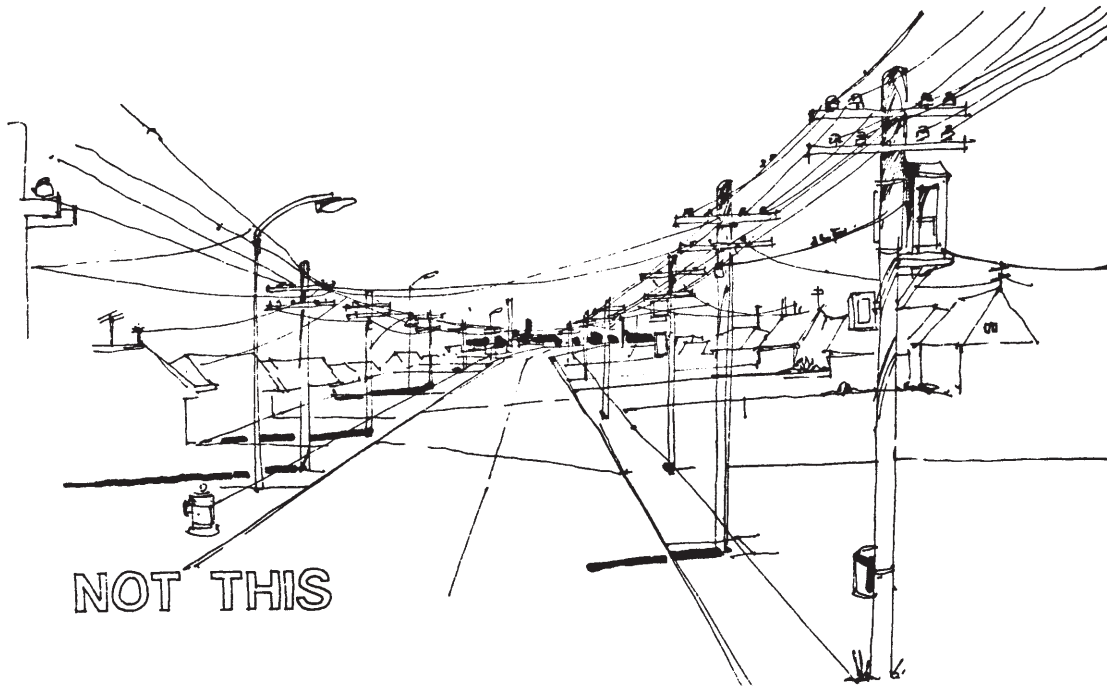

SIGNS

- On-premise signs should be integrated with the architectural design of the structure and should not extend above the roof line of the structure.
- Signs should be simple, well designed and constructed of materials which harmonize with their surroundings.
- Brightly illuminated, colored, rotating, reflective, blinking, flashing or moving signs, pennants or streamers should not be permitted.

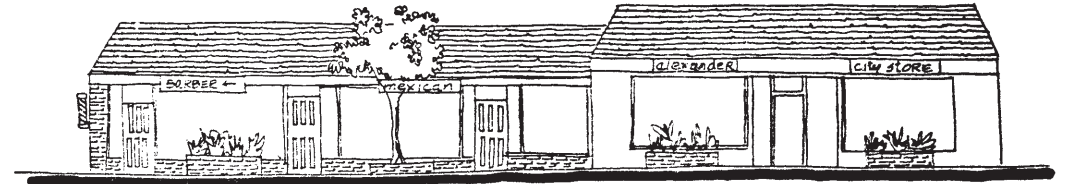

THIS

Signs are in scale with the structure and do not distract from it.

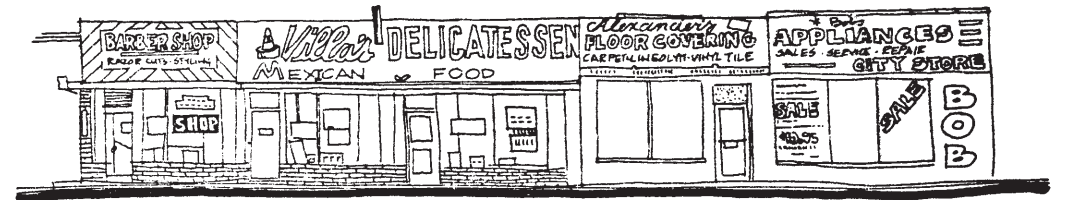

NOT THIS

Large, gaudy signs which are out of scale and do not relate to the structure are visually distracting.

EXTERIOR APPEARANCE

COLORS AND MATERIALS

- Exterior colors and materials should blend with the natural setting and surrounding neighborhood. The use of natural materials and earth colors are encouraged; highly reflective surfaces and colors are discouraged.

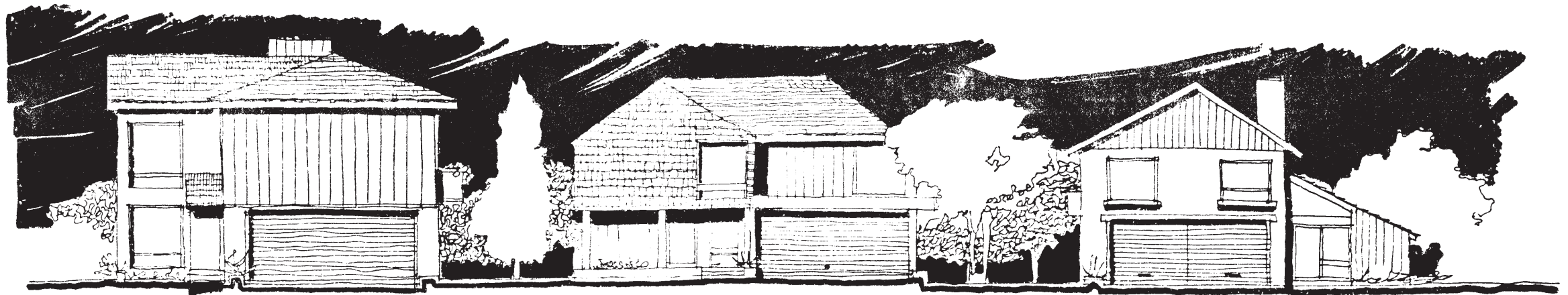

Varying architectural styles can be made compatible through the use of similar materials and colors.

STRUCTURAL SHAPES

- Simple structural shapes should be used to unify building design and to maintain an uncluttered community appearance.
- As roofs are a visually dominant feature in a community, it is important that simple shapes, non-reflective surfaces, and a simple range of materials and colors be used in their construction.
- Stacks, vents, antennas and other equipment should be organized to emerge together, screened from view and located on the least noticeable side of the roof.



THIS

Structure relates in size and scale with adjacent buildings.



NOT THIS

Continuous repetition of shapes and forms without variation creates a dull, uninteresting appearance.

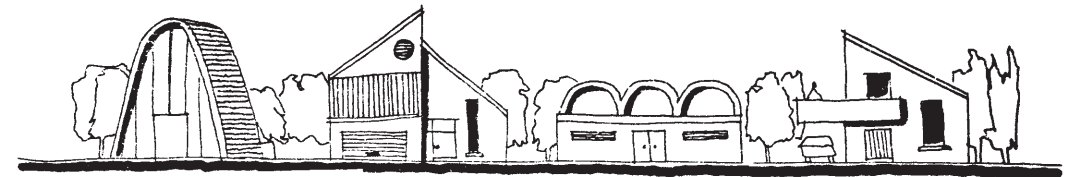

NOT THIS

Conflicting shapes, forms and styles create an unharmonious appearance.

SCALE



THIS

Structures relate in size and scale, creating a harmonious appearance from the street.

- Structures should relate in size and scale to adjacent buildings and to the neighborhood in which they are located.

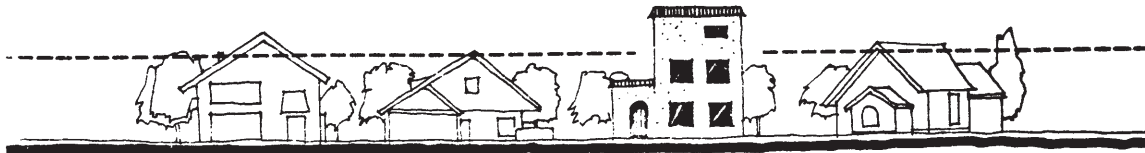

NOT THIS

Structure does not relate to adjacent buildings, interrupting the visual rhythm of the streetscape.

NON-RESIDENTIAL DEVELOPMENT

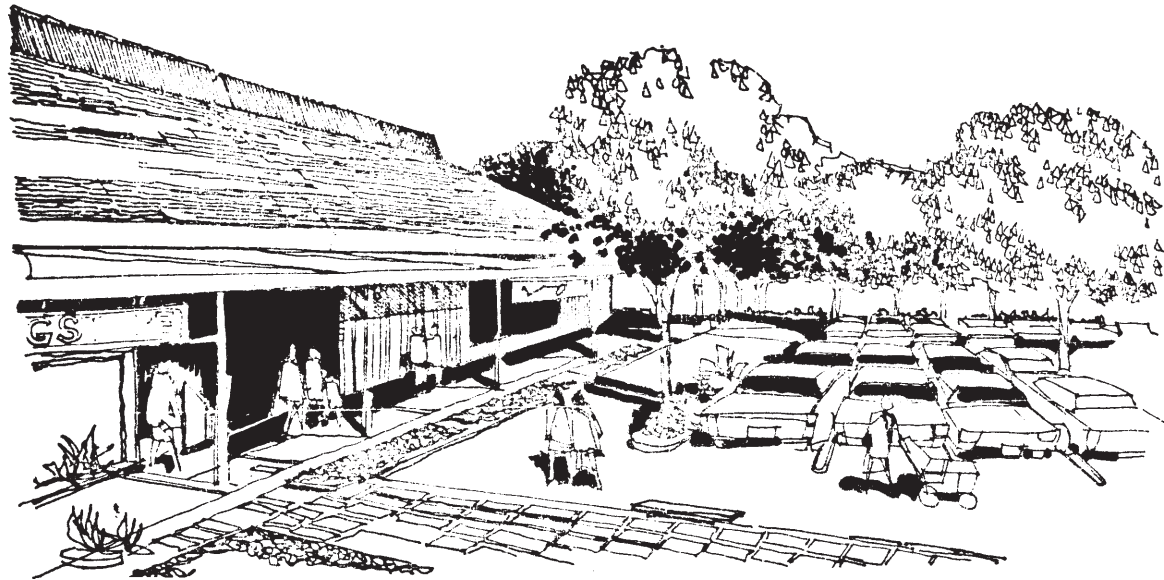

THIS

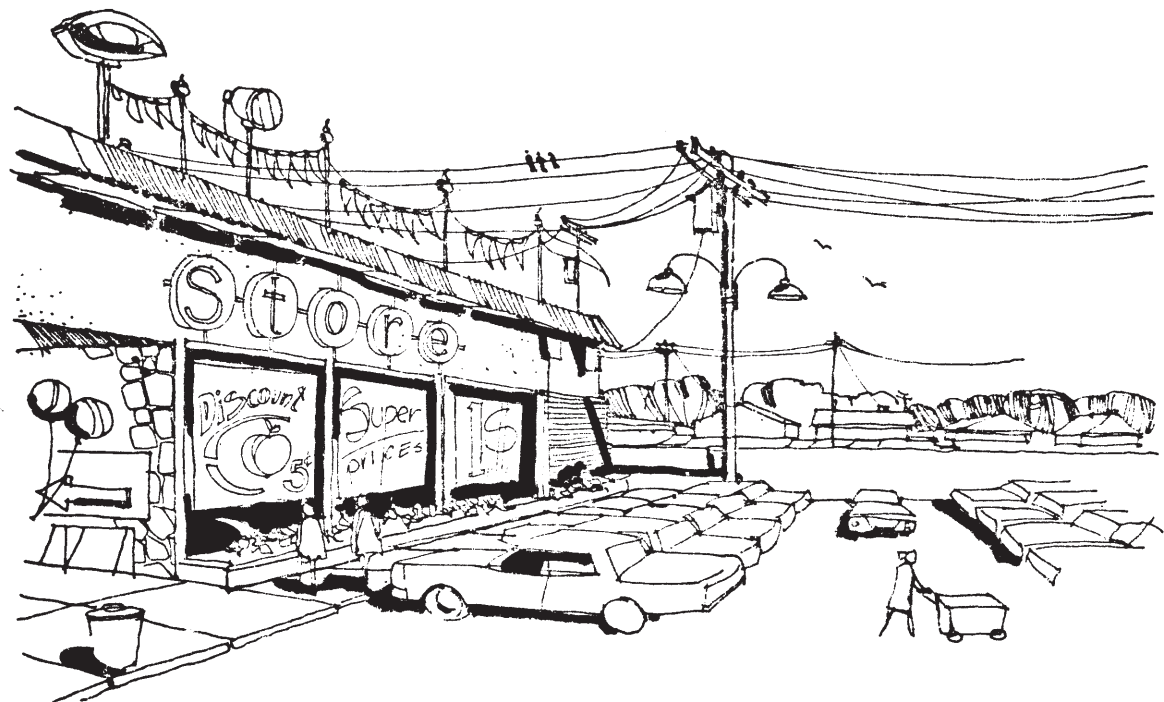

NOT THIS

COMMERCIAL

Here the character of the commercial center is compatible with the surrounding community. An arcade provides a human scale at the edge of the building as well as providing sun control, weather protection and an organized framework for signs. Materials have been chosen that blend with site environment. The introduction of decorative paving and planting make the center a pleasant place to visit. Handsome graphics advertise the center yet do not overpower the surroundings.

In the parking area, trees have been used to break up the hot expanse of parked cars with pools of shade. Denser tree plantings are provided around the site to shield the surrounding residential development. Parking rows are laid out so that the aisles lead conveniently towards the store.

This neighborhood commercial center illustrates a number of design problems. The project is not well integrated with the environment of the surrounding community. The building is much larger in scale than the surrounding houses, is set in a large bare parking lot and makes use of shiny materials, flapping pennants, and large signs.

Landscaping of the site is at a bare minimum. The parking lot consists of an expanse of unrelieved asphalt and is laid out with rows running parallel to the storefront, forcing shoppers to thread their way between parked cars.

INDUSTRIAL

In this illustration, the building is in scale with the site. Outside storage has been organized in a functional, yet visually appealing way. The service yards are suitably paved, and provisions have been made for parking and loading on the side. An inviting entrance is provided with a prominent but fitting sign. Extra effort has been spent to make this factory and its surroundings a humane place for people to work. Trees and lawns provide outlooks and a relief from hard surfaces and presents a handsome appearance from the street.

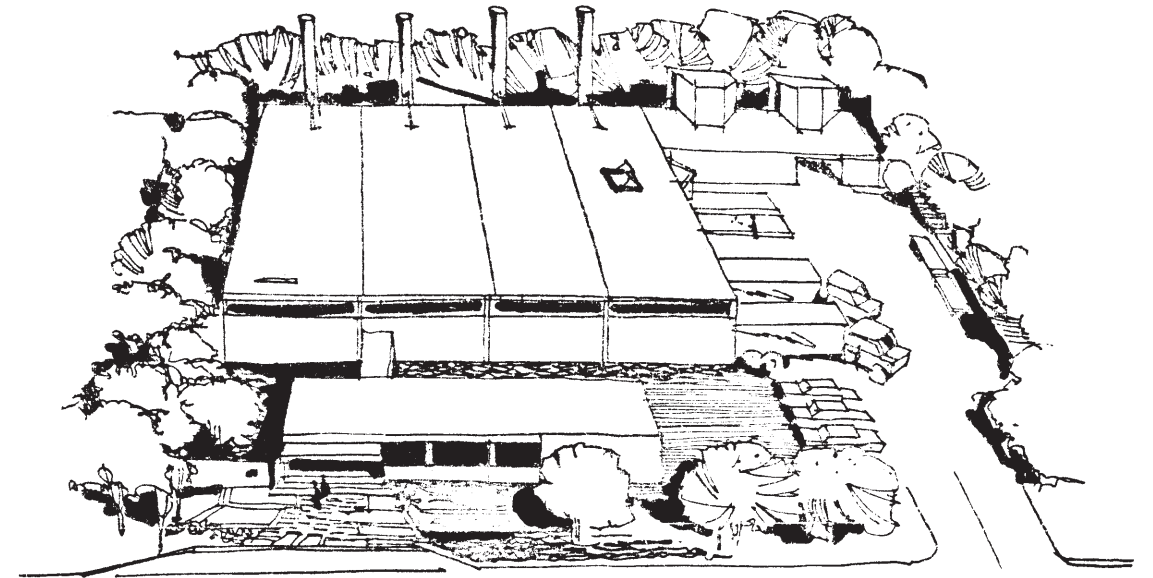

THIS

This illustrates an industrial plant which has been poorly designed; storage of materials and equipment is not organized. The traffic area of the site is unpaved or poorly paved. The loading dock at the front is small so trucks often project into the street. The building is devoid of character. On one corner an effort has been made to improve the office area with an unrelated facade and a small patch of grass. The large sign on the roof is out of scale. Outside of the minimal landscaping of the office entrance, the lot is barren of vegetation.

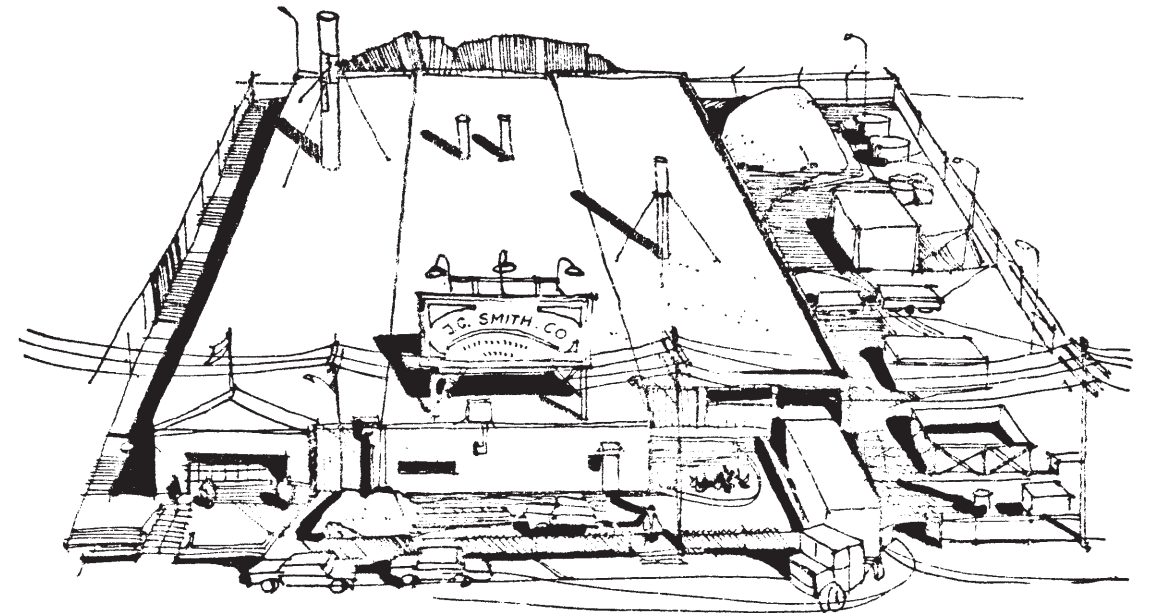

NOT THIS

APPENDIX

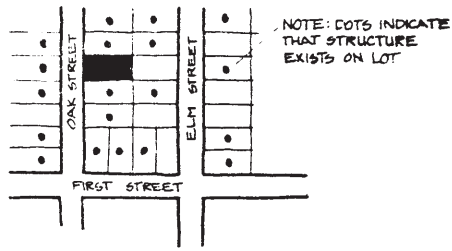

LOCATION MAP
100' = 1"

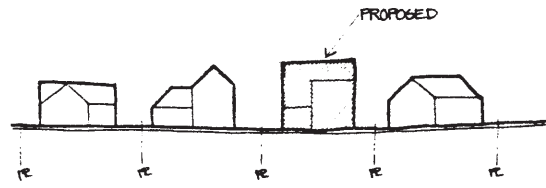

STREET ELEVATION
20' = 1"

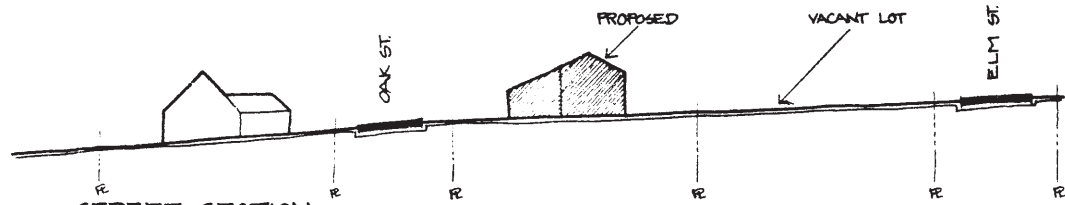

STREET SECTION
20' = 1"

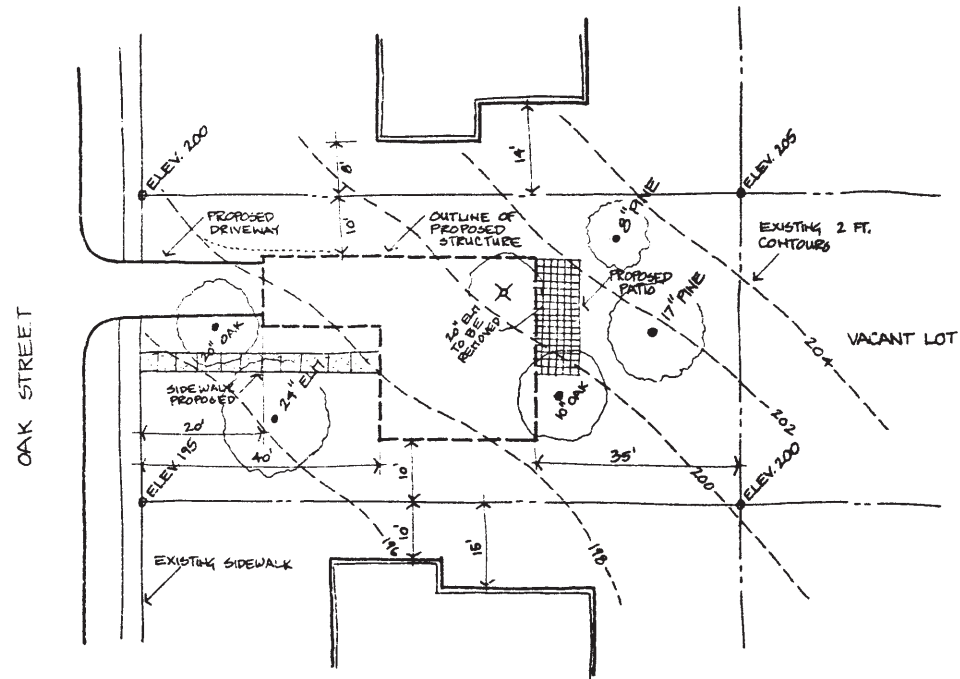

SITE PLAN
1/8" = 1'0"

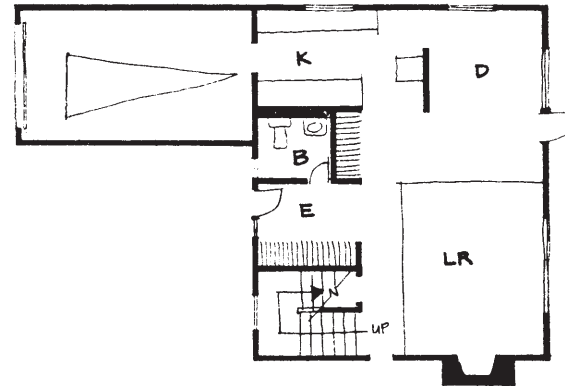

FIRST FLOOR

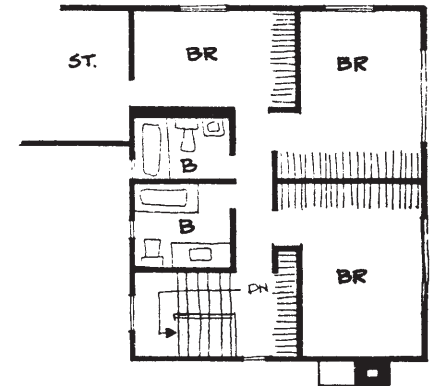

SECOND FLOOR

FLOOR PLANS
1/4" = 1'0"

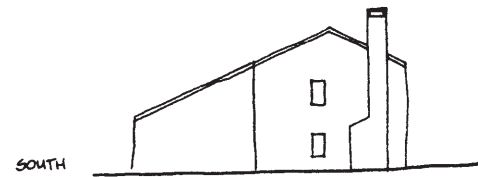

SOUTH



NORTH

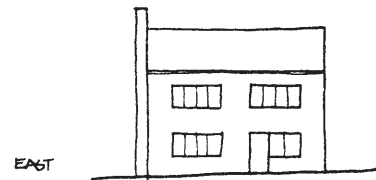

EAST

BUILDING ELEVATIONS
1/8" = 1'0"

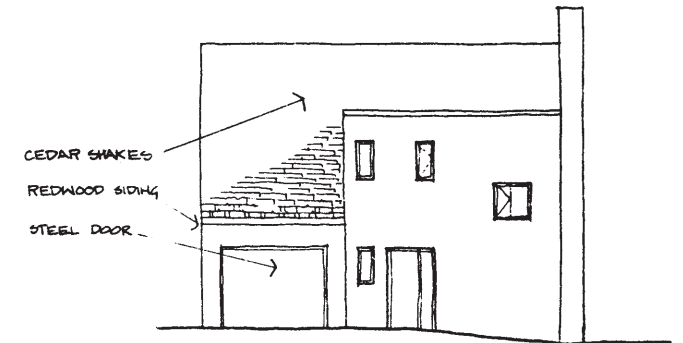

WEST

WEST (STREET) ELEV.
1/4" = 1'0"

SAMPLE PLANS

OWNERS NAME JOHN DOE	PROJECT ADDRESS 200 OAK ST.
DATE 9/26/75	MONTARA, CALIF.

DESIGN REVIEW CHECKLIST

APPLICATION

The application submitted for review by the Design Review Administrator shall contain the following information:

1. Site Plan Showing: (Minimum scale: 1 inch = 20 feet)
 - a. Property lines.
 - b. Existing and proposed ground contours.
 - c. Easements and utility lines.
 - d. Existing and proposed buildings.
 - e. All proposed improvements, including paving, fences, etc.
 - f. All existing trees and size.
 - g. Trees to be removed.
2. Building Elevations Showing: (Minimum scale: ¼ inch = 1 foot)
 - a. All exterior walls.
 - b. Type of roof and exterior materials to be used.
 - c. Color of materials.
 - d. Location of roof equipment, trash enclosures, fences, exterior lights, or other structure or fixtures to be located outside the building.
 - e. Sign location showing relationship to building's architecture.
3. Location map showing the building site, adjacent lots and streets. Indicate if adjacent lots are developed or vacant.
4. Any additional information as determined by the Design Review Administrator necessary for evaluation of the development plans.

DESIGN REVIEW (DR) ZONING ORDINANCE

GENERAL

In any district which is combined with the “DR” District, the regulations specified in this chapter shall apply.

In addition to the regulations set forth in Chapter 27, Section 6550 et seq., proceedings for the determination of an area for the application of these regulations may also be initiated by a petition of the majority of the property owners in a given area. Upon receipt of such a petition, the Planning Director shall set a date of hearing thereof, and give a notice as set forth in Section 6551 of the San Mateo County Ordinance Code. This chapter shall apply to all new exterior construction, grading and signs which require a permit. No such permit shall be issued in any area subject to the regulations of this chapter as determined by the Board of Supervisors unless the design of the project has been approved by the Design Review Administrator in compliance with this chapter. Before an occupancy permit is issued, the completed building must be inspected by the Zoning Investigator for compliance with the decision of the Design Review Administrator.

Grading shall not be started until after a grading permit has been approved by the Design Review Administrator in compliance with this chapter, if a grading permit is required under Chapter 70 Unified Building Code or under the provisions of Section 8600 of the County Ordinance Code.

FINDINGS

The Board of Supervisors hereby finds that:

1. Many communities, neighborhoods and areas in this County have deteriorated through poor planning, neglect of proper design standards, and the erection of buildings and structures unrelated to the sites, incompatible with the character of the neighborhood and insensitive to the natural environment, especially in older undeveloped or partially developed platted areas, existing and proposed communities, clustered developments and areas with unique environmental and/or resource value;
2. These conditions promote disharmony, reduce property values, and impair the public health, safety, comfort, convenience, happiness, and welfare;
3. The lack of appropriate guidelines and criteria for the design of new buildings and structures contributes to these conditions;
4. It is necessary and desirable to alleviate these conditions by providing appropriate guidelines and criteria for the maintenance and enhancement of property values, the visual character of especially fragile communities, the natural environmental resources, and the public health, safety, comfort, convenience, happiness, and welfare of the citizens of the County.

5. The review procedures of this chapter will more effectively preserve and enhance the property values, the visual character of especially fragile communities, the natural environmental resources and the public health, safety, comfort, convenience, happiness, and welfare of the citizens of the County.

PURPOSES

The purposes of this chapter are:

1. To recognize the interdependence of land values and aesthetics and to provide a method by which the County may encourage builders to develop land so that its value and attractiveness will endure;
2. To encourage development of private property in harmony with the desired character of the community or area in conformance with an adopted set of community design principles as well as the County General Plan and other Precise Plans;
3. To avoid and prevent community deterioration and to encourage the preservation and enhancement of property values and the visual character of communities and natural resources;
4. To improve the general standards for orderly and stable development in the County through design review of individual buildings, structures, and their setting;
5. To improve and augment the regulations now included in ordinances related to planning, building and health in order to promote development which is in the best interest to the public health, safety and welfare of the County;

6. To establish standards and policies that will promote, preserve, and enhance building design, proper site development, and other environmental characteristics in communities and areas where previous planning and zoning controls have been found inadequate for these purposes and the economic and physical stability is threatened by new development.

It is not a purpose of this chapter that regulation of design should be so rigidly interpreted that individual initiative is precluded in the design of any particular building or substantial additional expense is incurred. Rather, it is the intent of this that any regulation exercised be the minimum necessary to achieve the overall objectives of this chapter.

Furthermore, it is the intent of this Board that, prior to the Design Review Administrator's reviewing any application under the procedures set forth in this chapter, a set of specific design review guidelines shall be developed for the communities in which the regulation of this chapter apply. The design review guidelines shall be developed in accordance with procedures that will insure opportunity for the citizens of such communities to present their views. The design review guidelines so developed shall be supplemental to and a part of the Community Design Manual approved and adopted by the Board of Supervisors as policy for the application of this chapter.

REVIEW OF PLANS

All applications for building or grading permits for any construction in any district which is combined with the "DR" District must be submitted for approval by the Design Review Administrator in accordance with this chapter.

ESTABLISHMENT OF DESIGN REVIEW ADMINISTRATOR.

The Director of Planning is the Design Review Administrator. He may appoint in writing an assistant to act as the Design Review Officer, who may exercise all of the powers of the Design Review Administrator.

Duties:

The Design Review Administrator shall be empowered to review applications for building and grading in any area subject to the provisions of this chapter. He may refer any matter directly to the Planning Commission when, in his opinion, such action will be in the public interest.

Applications:

Applications shall be submitted on forms supplied by the Design Review Administrator. He may prescribe the form and scope of all applications and establish filing deadlines subject to any provisions of State statutes or County ordinances or policies.

The Design Review Administrator shall: a) approve the application as submitted; b) approve the application with modifications; c) refer the application to the Planning Commission; or d) disapprove the application. If modifications are required of the proposed design or if it is disapproved, the Administrator shall state reasons in writing for his actions. The Administrator shall act upon each application within fifteen (15) days from filing unless the applicant consents to a longer period of time. The approval of the Design Review Administrator is valid for no longer than one (1) year, at the end of which time, if a building permit has not been issued, the design approval is void.

Decisions.

Written notice of the decision and the findings, if required, shall be mailed to the applicant by first-class mail at the address set

forth in the application and to any other person who has filed a written request with the Design Review Administrator.

APPLICATION

The application submitted for review by the Design Review Administrator shall contain the following information:

1. Site Plan Showing: (Minimum scale: 1 inch = 20 feet)
 - a. Property lines.
 - b. Existing and proposed ground contours.
 - c. Easements and utility lines.
 - d. Existing and proposed buildings.
 - e. All proposed improvements, including paving, fences, etc.
 - f. All existing trees and size.
 - g. Trees to be removed.
2. Building Elevations Showing: (Minimum scale: ¼ inch = 1 foot)
 - a. All exterior walls.
 - b. Type of roof and exterior materials to be used.
 - c. Color of materials.
 - d. Location of roof equipment, trash enclosures, fences, exterior lights, or other structure or fixtures to be located outside the building.
 - e. Sign location showing relationship to building's architecture.
3. Location map showing the building site, adjacent lots and streets. Indicate if adjacent lots are developed or vacant.
4. Any additional information as determined by the Design Review Administrator necessary for evaluation of the development plans.

STANDARDS FOR REVIEW.

1. The Design Review Administrator and, on appeal, the Planning Commission and the Board of Supervisors, in reviewing proposals under this chapter, shall find that the proposal conforms with the following guidelines and standards before approving issuance of a permit:
 - a. proposed structures are designed and situated so as to retain and blend with the natural vegetation and land forms of the site and to insure adequate space for light and air to itself and adjacent properties;
 - b. where grading is necessary for the construction of structures and paved areas, it blends with adjacent land forms through the use of contour grading rather than harsh cutting or terracing of the site and does not create problems of drainage or erosion on its site or adjacent property;
 - c. streams and other natural drainage systems are not altered so as to affect their character and thereby causing problems of drainage, erosion or flooding;
 - d. structures are located outside flood zones, drainage channels and other areas subject to inundation;
 - e. trees and other vegetative land cover are removed only where necessary for the construction of structures or paved areas in order to reduce erosion and impacts on natural drainage channels, and maintain surface runoff at acceptable levels;
 - f. a smooth transition is maintained between development and adjacent open areas through the use of natural landscaping and plant materials which are native or appropriate to the area;
 - g. views are protected by the height and location of structures and through the selective pruning or removal of trees and vegetative matter at the end of view corridors;
 - h. construction on ridgelines blends with the existing silhouette by maintaining natural vegetative masses and land forms and does not extend above the height of the forest or tree canopy;
 - i. structures are set back from the edge of bluffs and cliffs to protect views from scenic areas below;
 - j. varying architectural styles are made compatible through the use of similar materials and colors which blend with the natural setting and surrounding neighborhood;
 - k. the design of the structure is appropriate to the use of the property and is in harmony with the shape, size and scale of adjacent buildings in the community;
 - l. overhead utility lines are placed underground where appropriate to reduce the visual impact in open and scenic areas;

- m. the number, location, size, design, lighting, materials, and use of colors in signs are compatible with the architectural style of the structure they identify and harmonize with their surroundings;
- n. paved areas are integrated into the site, relate to their structure, and are landscaped to reduce visual impact from residential areas and from roadways.

2. In making such findings, the Design Review Administrator and, on appeal, the Planning Commission and the Board of Supervisors shall apply the following principles:

- a. regulation of design should not be so rigidly enforced that individual initiative is precluded in the design of any particular building or substantial additional expense incurred; rather, the regulation exercised should only be the minimum necessary to achieve the overall objectives as set forth in Section 6565.3;
- b. appropriate design is based upon the suitability of a building for its purposes, upon the appropriate use of sound materials and upon the principles of harmony and proportion in the elements of the building;
- c. appropriate design is not based on economic factors alone.

FINAL ACTION

No building permit for a building, sign, or other structure coming within this ordinance, nor any grading permit, shall be issued until the plans either as submitted or as modified by agreement with the applicant are approved by the Design Review Administrator or upon appeal by the Planning Commission or Board of Supervisors. Upon approval, and provided all other provisions of law are complied with, the Director of Building Construction shall issue a permit for such building, sign, or structure, or for such grading.

APPEALS

All decisions of the Design Review Administrator shall be subject to appeal by the applicant or any interested party to the Planning Commission within fifteen (15) calendar days of the decision. Appeals shall be by written notice to the Director of Planning on a form provided by the Planning Department. The fee for such appeal shall be the same as for filing an appeal from a decision of the Planning Commission, as set forth in Section 6583 of the Zoning Annex. The decision of the Planning Commission may be appealed to the Board of Supervisors in accordance with the provisions of the San Mateo County Ordinance Code.

PREPARED BY THE SAN MATEO COUNTY
PLANNING DEPARTMENT
REDWOOD CITY ▪ CALIFORNIA

BOARD OF SUPERVISORS

John M. Ward, Chairman

Edward J. Bacciocco, Jr.

James V. Fitzgerald

Fred Lyon

William H. Royer

PLANNING COMMISSION

Mem Levin, Chairman

Ernest Galeotti

Conrad Pavellas

Lore Radisch

Wayne Thomas

PARTICIPATING PLANNING STAFF

Donald A. Woolfe Director

William F. Powers Assistant Director

George P. Miller Project Planner

GRAPHICS

Bernard Burton Graphics Director

Michael Murphy Drafting Technician

John Baumgarten Drafting Technician

ILLUSTRATIONS

Harte, Krivatsy & Stubee

Planning Consultants

Cover: Bernard Burton